

Specifications

- Current rating: 1A AC,DC
- Voltage rating: 100V AC,DC
- Temperature range: -25°C~+85°C
- Contact resistance: 30mΩMax.
- Insulation resistance: 500MΩMin.
- Withstanding voltage: 500V AC/minute
- *Compliant with RoHS and REACH*
- *Meet the HF/Halogen Free, need to customize*
- *Contact HDGC for details*

Assembly layout

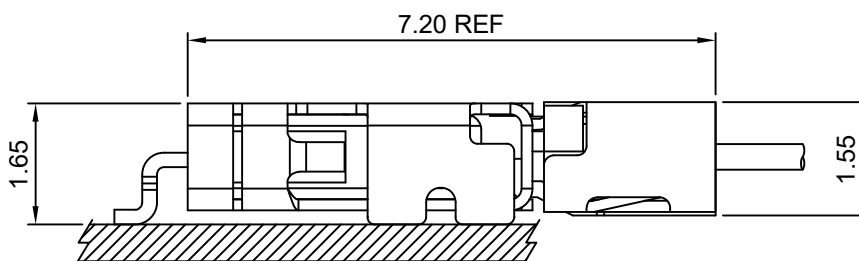



HDGC1004 Series 1.00mm (.039") Pitch Wire to Board Connector

HDGC1004-T

1.00mm pitch Crimp Terminal

Reference Informations:

*Used in HDGC1004H-XP series Housing

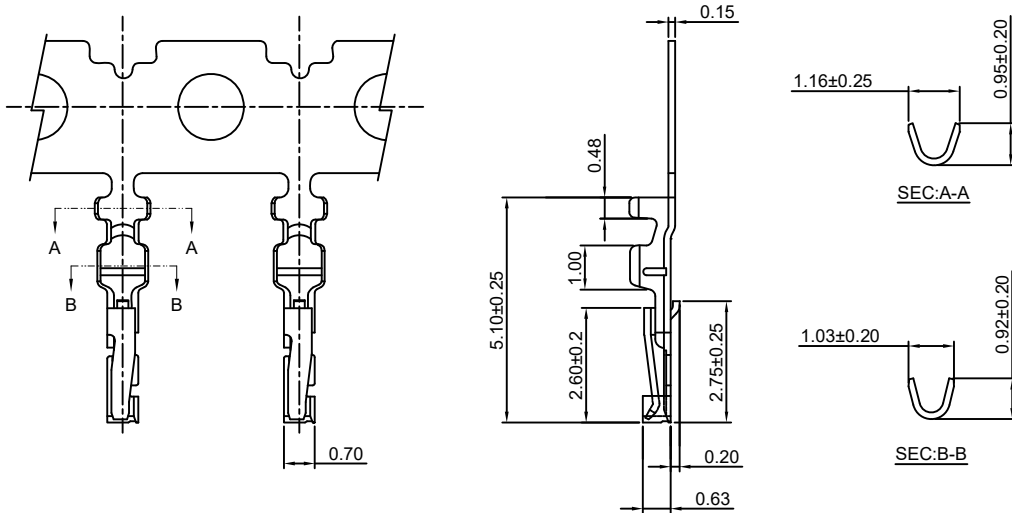

Ordering information & Specifications:

Unit:mm

Part NO.	Wire Range	Insulation O.D.	Material	Finish	Qty/reel
HDGC1004-GP	AWG#28-#32	0.60mm(max)	Phosphor Bronze	Gold over Nickel	15,000 PCS

Optional Gold plating available but MOQ requested

HDGC1004H-XP

1.00mm pitch Housing

Reference Informations:

*Material: Insulator:Nylon 66,UL94V-0

Shell:Phosphor Bronze/Tin over Nickel

*Suitable HDGC1004-T series Terminal

*Mates with HDGC1004WR-S-XP series Wafer

*Color:Ivory

Ordering Information:

HDGC1004H-XP - ***

1 2

1.Part No.

2.Material:

(Blank):Nylon 66,UL94V-0

GWT:Nylon 66,UL94V-0,GWT 750 °C

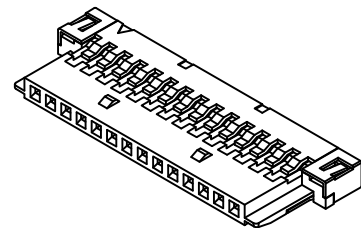
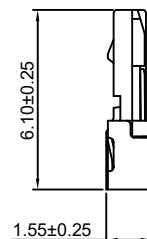
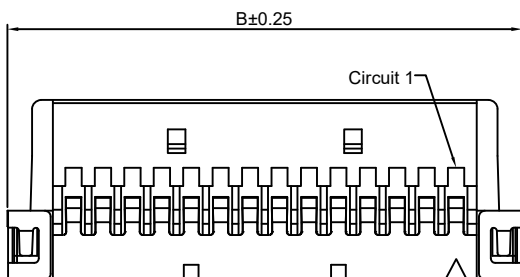
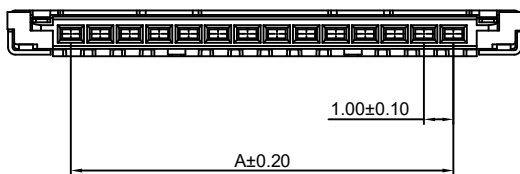

Ordering Information & Dimensions:

PART NO.	Dimensions	
	A	B
8P	7.00	11.50
14P	13.00	17.50
20P	19.00	23.50
30P	29.00	33.50

Unit: mm



HDGC1004 Series 1.00mm (.039") Pitch Wire to Board Connector

HDGC1004WR-S-XP

1.00mm pitch 90° Wafer-SMT TYPE

Reference Informations:

- *Material: Pin: Phosphor Bronze/Gold over Nickel
Shell: Phosphor Bronze/Tin over Nickel
Insulator: Nylon 6T, UL94V-0
- *Mates with HDGC1004H-XP series Housing
- *Color: Ivory

Ordering Information:

- HDGC1004WR-S-XP - ***
1 2
1. Part No.
 2. Material:
(Blank): Nylon 6T, UL94V-0
GWT: Nylon 6T, UL94V-0, GWT 750 °C

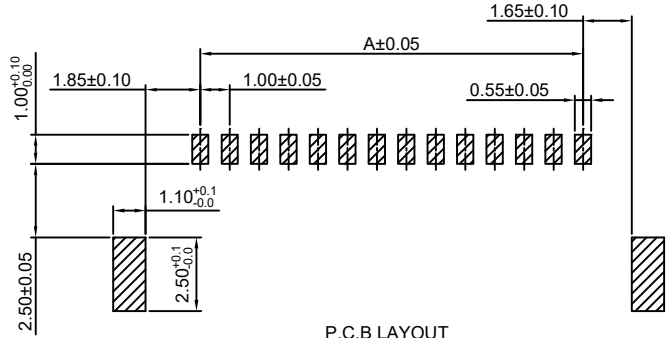
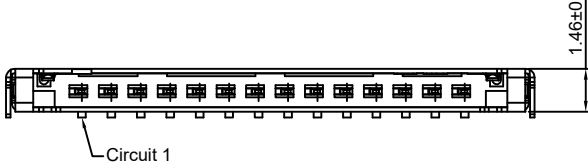
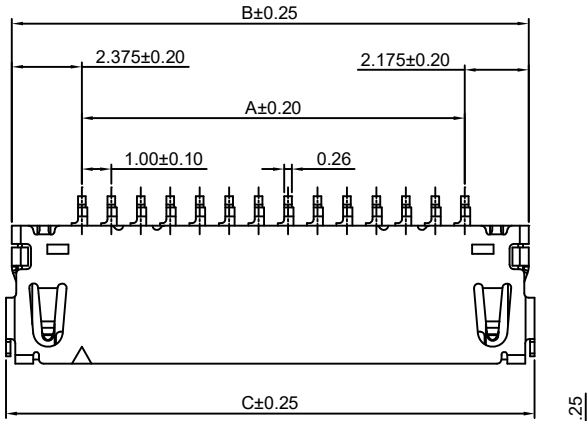

P.C.B LAYOUT

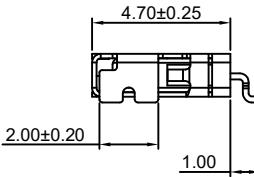
**Ordering Information & Dimensions:**

PART NO.	Dimensions		
	A	B	C
8P	7.00	11.50	11.95
14P	13.00	17.50	17.95
20P	19.00	23.50	23.95
30P	29.00	33.50	33.95

Unit: mm